



FS301- Free Standing Series Single Sided

Assembly Instructions

Post Assembly

Remove Posts and Sign Assembly from carton, set aside. Remove Base Plate which is located under the cardboard pad in the bottom of the carton. Locate the post with the exposed threaded stud (A). Apply a small amount of thread locker to the end of the stud and thread into either end of the second post tube.

Base Assembly

Apply thread locker to the bottom bolt (C) and attach Base as shown.

Sign Assembly Attachment

Apply thread locker to remaining bolt (C) and attach Sign Assembly as shown.

FS300 Inclined Display (Single Sided)

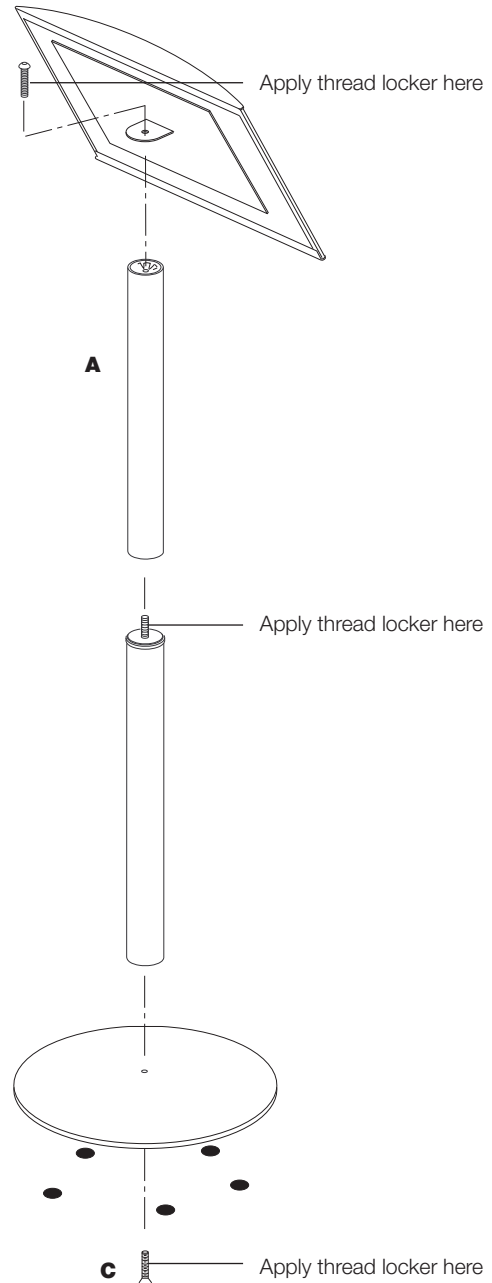

FS301 Vertical Display (Single Sided)

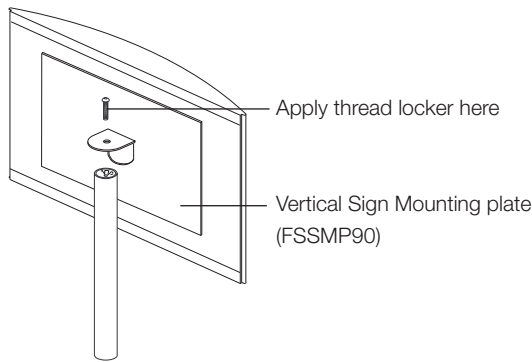

Description	QTY/Assy
A. Post Assembly	(1)
B. Base Plate	(1)
C. Fasteners	(2)
D. Sign Assembly	(1)
E. Locking Pins	(2)

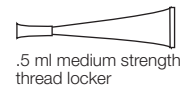
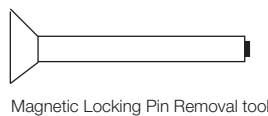
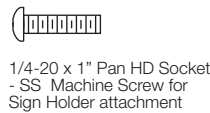
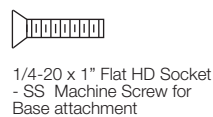



FS301.2 - Free Standing Series Double Sided

Assembly Instructions

Base Assembly

Remove Base Plate which is located under the cardboard pad in the bottom of the carton. Apply thread locker to the bottom bolt (C) and attach Base to tube with exposed stud as shown.

Post Assembly

Place Splice Connector over the exposed threaded stud. Apply a small amount of thread locker to the end of the stud and thread second post tube hand tighten turning clockwise.

Sign Assembly Attachment

Apply thread locker to exposed thread and attach Post extension to the post. Hand tighten turning clockwise.

Place sign assembly over the Post and align hole to top of tube. Apply thread locker to the pan head bolt and use the allen wrench to secure the sign to the post. Caution: do not over tighten.

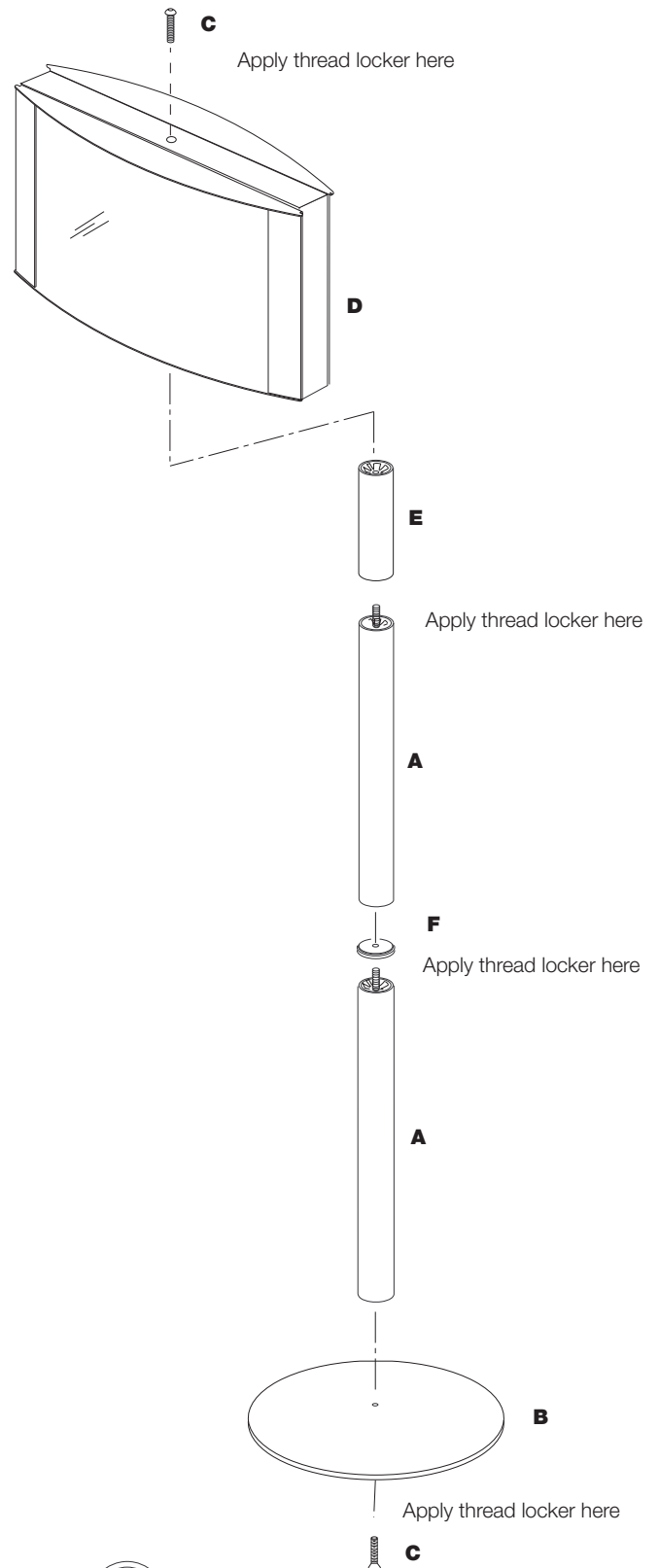

Description	QTY/Assy
A. Post Assembly	(2)
B. Base Plate	(1)
C. Fasteners	(2)
D. Sign Assembly	(1)
E. Post Extension	(1)
F. Splice Connector	(1)



1/4-20 x 1" Pan HD Socket
- SS Machine Screw for
Sign Holder attachment



5/32" Hex Wrench

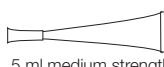

.5 ml medium strength
thread locker



Splice Connector
FSST-SC