

MyDay is a modular system for displaying multiple types of useful information within a small area, eliminating clutter and confusion.



Horizontal Series - Overview

MyDay is a modular system for displaying multiple types of information within a small area, eliminating clutter and confusion. It is a focal point, incorporating a high-quality blend of form and function.

Displays may be removed and changed or replaced with a unique lift-and-pull technique. Should a display become damaged or if a change is desired, the update is fast and easy.

Although initially designed for healthcare environments, MyDay provides ideal display solutions for corporate, education and government facilities as well.

Frame/Cabinet Sizes

- Heights: 16" or 20"
- Widths: 16", 32", 48" or 64"

Frame Shape Options/Codes

Square: **MDS**
Radius: **MDR**

Frame Cabinet Finishes

- Natural Satin Anodized (standard)
- Black Anodized
- A43 Putty (painted)
- Simulated Wood Grain (vinyl clad)
Maple, Walnut, Oak, Cherry and Mahogany

Vertical Divider Finishes

- Satin Anodized (standard)
- Black Anodized
- A43 Putty (painted)

Display Options

- Fabric Covered PinBoard
- Rubberized Coark PinBoard
- MarkerBoard
with or without text/graphics
- Clocks
- COM
Customers Own Material

Accessory Options

- Magazine Holder
- Hanger Hooks
- Marker Rail / Shelf
- Notifier Display Clip

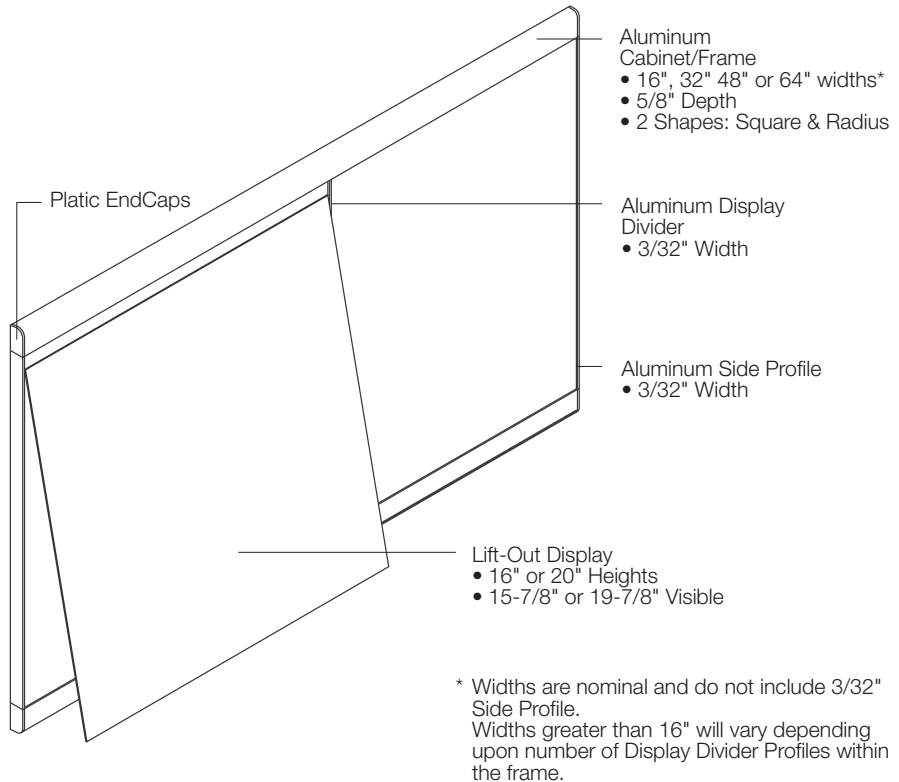

Common Configurations

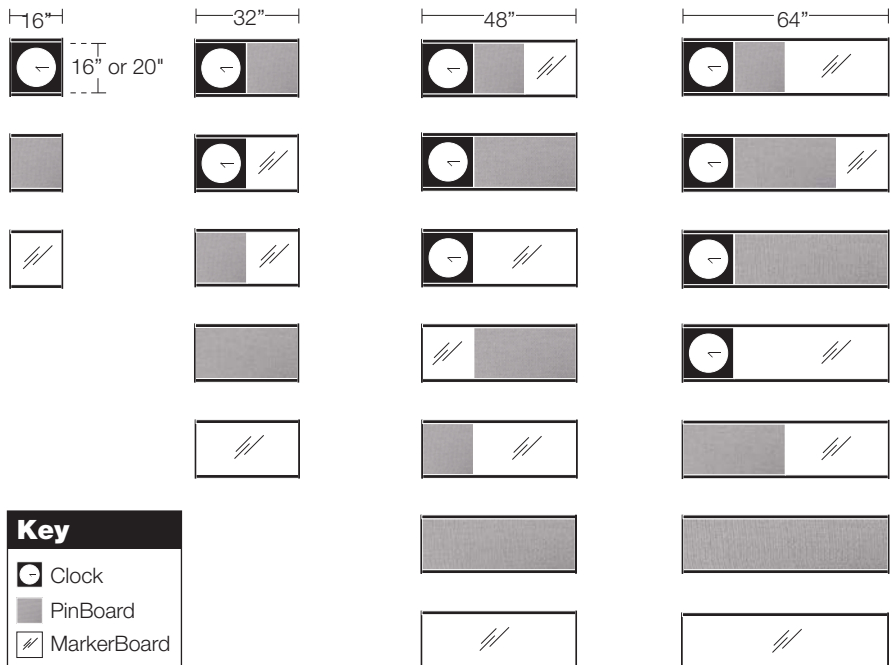

MyDay Series MDV Vertical offers the same features and benefits of the Horizontal Series with simply a different look.

Displays may be removed and changed with a unique lift-and-pull technique.

Frame/Cabinet Sizes

- Heights: 16", 32" or 48"
- Widths: 16" or 20"

Frame Shape Options/Codes

Square: **MDS**

Radius: **MDR**

Frame Cabinet Finishes

- Natural Satin Anodized (standard)
- Black Anodized
- A43 Putty (painted)
- Simulated Wood Grain (vinyl clad)
Maple, Walnut, Oak, Cherry and Mahogany

Horizontal Divider Finishes

- Satin Anodized (standard)
- Black Anodized
- A43 Putty (painted)

Display Options

- Fabric Covered PinBoard
- Rubberized Coark PinBoard
- MarkerBoard
with or without text/graphics
- Clocks
- COM
Customers Own Material

Accessory Options

- Magazine Holder
- Hanger Hooks
- Marker Rail / Shelf
- Notifier Display Clip

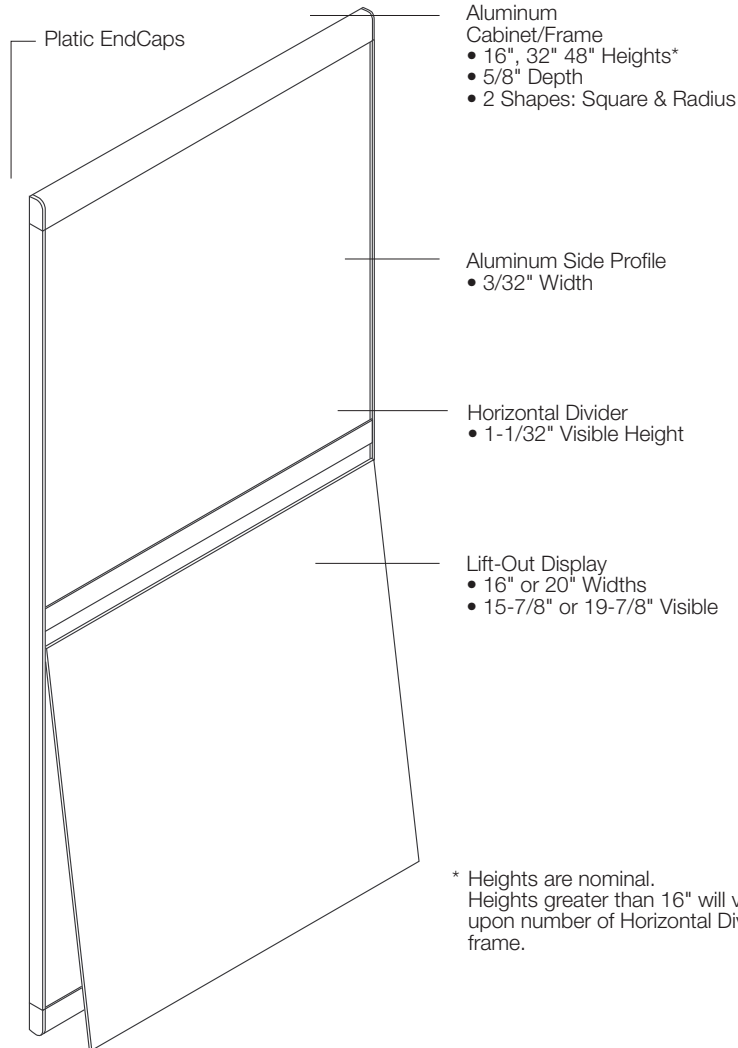

Common Configurations

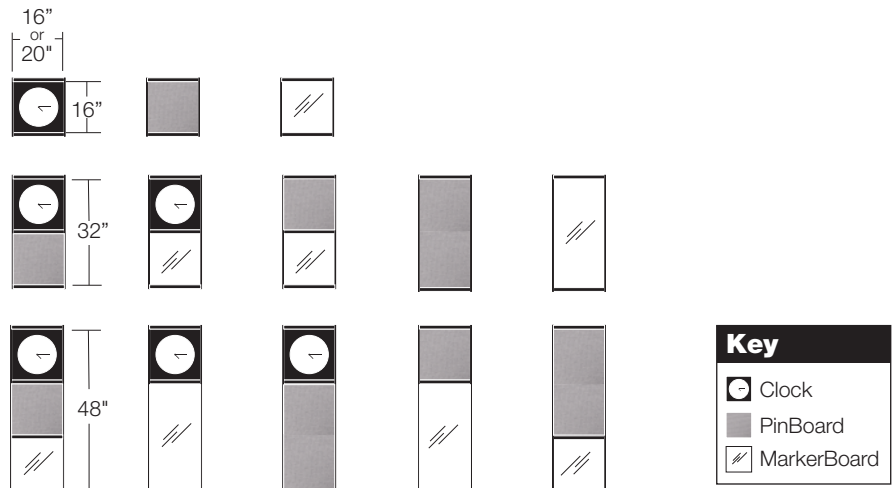

Horizontal Series 16" & 20" Frame Heights

MD16 16" Frame Height

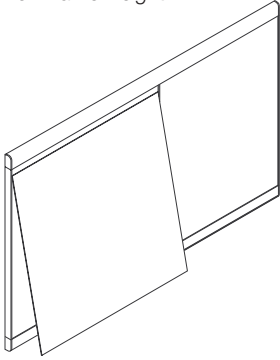

- Visible: 15-7/8"(h)
- OD: 18-7/32"(h)

Frame Shape Options/Codes

Square: **MDS**

Radius: **MDR**



MD_1616
ID: 16"(w)
OD: 16-7/32"(w)



MD_1648-00
ID: 48"(w)
OD: 48-7/32"(w)



MD_1664-000
ID: 64"(w)
OD: 64-7/32"(w)



MD_1664-110
ID: 64-9/32"(w)
OD: 64-15/32"(w)

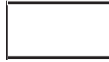

MD_1632-0
ID: 32"(w)
OD: 32-7/32"(w)

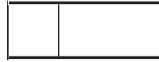

MD_1648-10
ID: 48-5/32"(w)
OD: 48-11/32"(w)

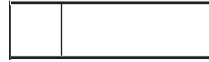

MD_1664-100
ID: 64-5/32"(w)
OD: 64-11/32"(w)

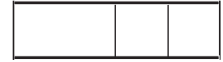

MD_1664-011
ID: 64-9/32"(w)
OD: 64-15/32"(w)



MD_1632-1
ID: 32-3/32"(w)
OD: 32-11/32"(w)



MD_1648-01
ID: 48-5/32"(w)
OD: 48-11/32"(w)



MD_1664-010
ID: 64-5/32"(w)
OD: 64-11/32"(w)



MD_1664-101
ID: 64-9/32"(w)
OD: 64-15/32"(w)



MD_1648-11
ID: 48-9/32"(w)
OD: 48-15/32"(w)



MD_1664-001
ID: 64-5/32"(w)
OD: 64-11/32"(w)



MD_1664-111
ID: 64-13/32"(w)
OD: 64-9/16"(w)

MD20 20" Frame Height

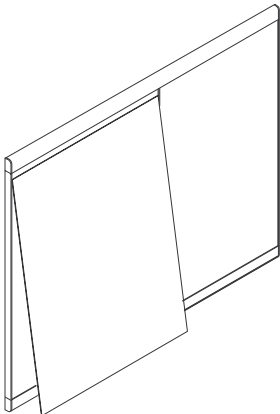

- Visible: 19-7/8"(h)
- OD: 22-7/32"(h)

Frame Shape Options/Codes

Square: **MDS**

Radius: **MDR**



MD_2016
ID: 16"(w)
OD: 16-7/32"(w)



MD_2048-00
ID: 48"(w)
OD: 48-7/32"(w)



MD_2064-000
ID: 64"(w)
OD: 64-7/32"(w)



MD_2064-110
ID: 64-9/32"(w)
OD: 64-15/32"(w)



MD_2032-0
ID: 32"(w)
OD: 32-7/32"(w)



MD_2048-10
ID: 48-5/32"(w)
OD: 48-11/32"(w)



MD_2064-100
ID: 64-5/32"(w)
OD: 64-11/32"(w)



MD_2064-011
ID: 64-9/32"(w)
OD: 64-15/32"(w)



MD_2032-11
ID: 32-3/32"(w)
OD: 32-11/32"(w)



MD_2048-01
ID: 48-5/32"(w)
OD: 48-11/32"(w)



MD_1664-010
ID: 64-5/32"(w)
OD: 64-11/32"(w)



MD_2064-101
ID: 64-9/32"(w)
OD: 64-15/32"(w)



MD_2048-11
ID: 48-9/32"(w)
OD: 48-15/32"(w)



MD_2064-001
ID: 64-5/32"(w)
OD: 64-11/32"(w)



MD_2064-111
ID: 64-13/32"(w)
OD: 64-9/16"(w)

Fabric Covered PinBoard



Sulphur Grey Fabric



Mintless Fabric

| Height | Width | Code |
|--------|-------|------------------|
| 16" | 16" | MDFPB1616 |
| | 32" | MDFPB1632 |
| | 48" | MDFPB1648 |
| | 64" | MDFPB1664 |
| 20" | 16" | MDFPB2016 |
| | 32" | MDFPB2032 |
| | 48" | MDFPB2048 |
| | 64" | MDFPB2064 |

Rubberized Cork PinBoard



Natural Cork

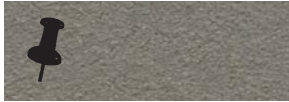

A47 Light Grey Cork

| Height | Width | Code |
|--------|-------|------------------|
| 16" | 16" | MDCPB1616 |
| | 32" | MDCPB1632 |
| | 48" | MDCPB1648 |
| | 64" | MDCPB1664 |
| 20" | 16" | MDCPB2016 |
| | 32" | MDCPB2032 |
| | 48" | MDCPB2048 |
| | 64" | MDCPB2064 |

Fabric Covered PinBoard - COM

Customer's Own Material

| Height | Width | Code |
|--------|-------|---------------------|
| 16" | 16" | MDCOMFPB1616 |
| | 32" | MDCOMFPB1632 |
| | 48" | MDCOMFPB1648 |
| | 64" | MDCOMFPB1664 |
| 20" | 16" | MDCOMFPB2016 |
| | 32" | MDCOMFPB2032 |
| | 48" | MDCOMFPB2048 |
| | 64" | MDCOMFPB2064 |

VERY IMPORTANT Notes Regarding COM (Customer's Own Material)

1. Subject to inspection of COM to determine suitability of use with the MyDay product.
Customer must provide yardage as specified by APCO.
2. COM material must be shipped to APCO Freight Prepaid.
3. APCO is not responsible for performance of COM, including variations in patterns, color or weaving.
4. APCO warranty does not apply to COM products.
5. All responsibility for COM shipments is between the customer and the material supplier.
6. Prices are subject to change after COM material is evaluated by APCO.

MarkerBoard (Masonite)

Blank w/White Background

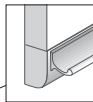

3/4" Aluminum Marker Tray
 • Standard with all MarkerBoards.
 • 2" Shelf is optional.

| Height | Width | Code |
|--------|-------|------------------|
| 16" | 16" | MDMBM1616 |
| | 32" | MDMBM1632 |
| | 48" | MDMBM1648 |
| | 64" | MDMBM1664 |
| 20" | 16" | MDMBM2016 |
| | 32" | MDMBM2032 |
| | 48" | MDMBM2048 |
| | 64" | MDMBM2064 |

MarkerBoard (AR Acrylic)

Blank OR w/Graphics

Non-White Background Color Optional

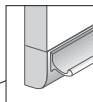
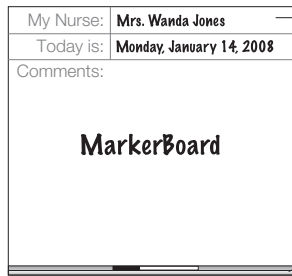

Permanent, subsurface silkscreen printed graphics or updatable digitally printed graphics as per client specifications.

3/4" Aluminum Marker Tray
 • Standard with all MarkerBoards.
 • 2" Shelf is optional.

| Height | Width | Code |
|--------|-------|------------------|
| 16" | 16" | MDMBA1616 |
| | 32" | MDMBA1632 |
| | 48" | MDMBA1648 |
| | 64" | MDMBA1664 |
| 20" | 16" | MDMBA2016 |
| | 32" | MDMBA2032 |
| | 48" | MDMBA2048 |
| | 64" | MDMBA2064 |

Clock Display

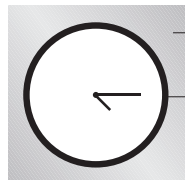

Clock Insert

Clock Bezel

Two Clock Options

1. 12-1/4" diameter radio controlled clock by Howard Miller* (#625-488)
2. 10-1/2" diameter standard battery opwered quartz clock by Howard Miller (#625-254)

* See www.apcosigns.com/myday.asp for important information, instructions and disclaimers regarding atomic clocks.

| Height | Width | Code |
|--------|-------|-----------------|
| 16" | 16" | MDCD1616 |
| 20" | 16" | MDCD2016 |

Finishes

Aluminum Clock Insert

- Natural Satin Anodized (standard)
- Painted
- Simulated Wood Vinyl

Clock Bezel

- Black

Hanger

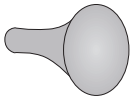

Finishes

Natural Satin Aluminum
Painted Black Aluminum
Other finishes not recommended

Important

Standard locations for hangers:
Single: Centered on 16" module
Double: Centered (see cover photo).
Otherwise, exact locations need to be specified by client.

Hanger holes are pre-drilled into bottom of frame/cabinet and hangers are attached by customer.

Code

MDHNGR

2"Shelf

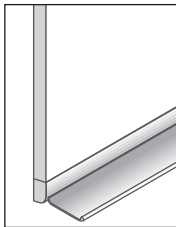

Finishes

Satin Aluminum
Other finishes not recommended

Ships unassembled. Attachment by customer with provided peel-and-stick adhesive.

Width

16"

32"

48"

64"

Code

MDSHLF16

MDSHLF32

MDSHLF48

MDSHLF64

Magazine Holder

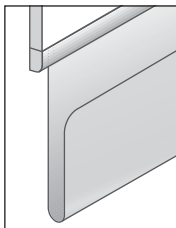

Finishes

Satin Aluminum
Other finishes not recommended

Ships unassembled. Attachment by customer with provided set screw.

Code

MDMHLDR

Notifier Clip

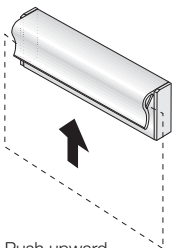

Push upward to grip paper.

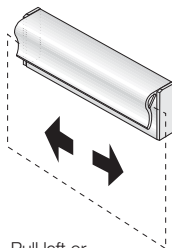

Pull left or right using both hands to release.

Finishes

Satin Aluminum (standard)
Painted (optional)

Width

16"

32"

48"

64"

Code

MDSB30N16

MDSB30N32

MDSB30N48

MDSB30N64

Vertical Series

16" & 20" Frame Widths

MD16

16" Frame Width

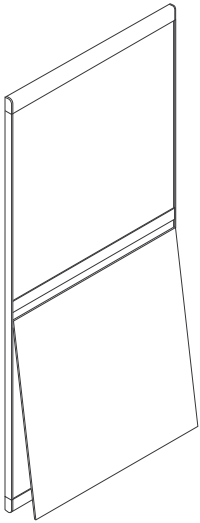

- ID: 16" w
- OD: 16-7/32" w



MD_1616
ID: 15-7/8" h
OD: 18-7/32" h



MD_3216
ID: 32" h
OD: 34-7/32" h

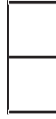

MD_3216-1
ID: 32-3/32" h
OD: 35-3/32" h



MD_4816-10
ID: 48-5/32" h
OD: 51-1/16" h



MD_4816-01
ID: 48-5/32" h
OD: 51-1/16" h



MD_4816-11
ID: 48_9/32" h
OD: 51-15/16" h

Frame Shape Options/Codes

Square: **MDS**

Radius: **MDR**

MD20

20" Frame Width

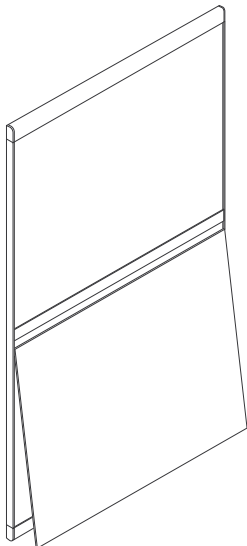

- ID: 20"
- OD: 20-7/32"



MD_1620
ID: 15-7/8" h
OD: 18-7/32" h



MD_3220
ID: 32" h
OD: 34-7/32" h



MD_3220-1
ID: 32-3/32" h
OD: 35-3/32" h

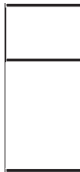

MD_4820-10
ID: 48-5/32" h
OD: 51-1/16" h

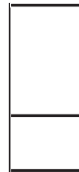

MD_4820-01
ID: 48-5/32" h
OD: 51-1/16" h

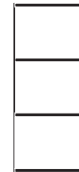

MD_4820-11
ID: 48_9/32" h
OD: 51-15/16" h

Frame Shape Options/Codes

Square: **MDS**

Radius: **MDR**

Fabric Covered PinBoard



Sulphur Grey Fabric



Mintless Fabric

| Width | Height | Code |
|-------|--------|-------------------|
| 16" | 16" | MDVFPB1616 |
| | 32" | MDVFPB3216 |
| 20" | 16" | MDVFPB1620 |
| | 32" | MDVFPB3220 |

Rubberized Cork PinBoard



Natural Cork

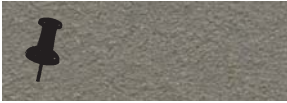

A47 Light Grey Cork

| Width | Height | Code |
|-------|--------|------------------|
| 16" | 16" | MDCPB1616 |
| | 32" | MDCPB3216 |
| 20" | 16" | MDCPB1620 |
| | 32" | MDCPB3220 |

Fabric Covered PinBoard - COM

Customer's Own Material

| Width | Height | Code |
|-------|--------|----------------------|
| 16" | 16" | MDVCOMFPB1616 |
| | 32" | MDVCOMFPB3216 |
| 20" | 16" | MDVCOMFPB1620 |
| | 32" | MDVCOMFPB3220 |

VERY IMPORTANT Notes Regarding COM (Customer's Own Material)

1. Subject to inspection of COM to determine suitability of use with the MyDay product.
 Customer must provide yardage as specified by APCO.
2. COM material must be shipped to APCO Freight Prepaid.
3. APCO is not responsible for performance of COM, including variations in patterns, color or weaving.
4. APCO warranty does not apply to COM products.
5. All responsibility for COM shipments is between the customer and the material supplier.
6. Prices are subject to change after COM material is evaluated by APCO.

MarkerBoard (Masonite)

Blank w/White Background

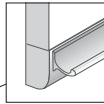

3/4" Aluminum Marker Tray
 • Standard with all MarkerBoards.
 • 2" Shelf is optional.

| Width | Height | Code |
|-------|--------|------------------|
| 16" | 16" | MDMBM1616 |
| | 32" | MDMBM3216 |
| 20" | 16" | MDMBM1620 |
| | 32" | MDMBM3220 |

MarkerBoard (AR Acrylic)

Blank OR w/Graphics

Non-white Background Color Optional

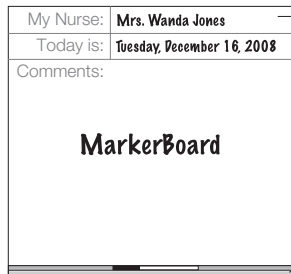

Permanent, subsurface silkscreen printed graphics or updatable digitally printed graphics as per client specifications.

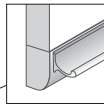

3/4" Aluminum Marker Tray
 • Standard with all MarkerBoards.
 • 2" Shelf is optional.

| Width | Height | Code |
|-------|--------|------------------|
| 16" | 16" | MDMBA1616 |
| | 32" | MDMBA3216 |
| 20" | 16" | MDMBA1620 |
| | 32" | MDMBA3220 |

Clock Display

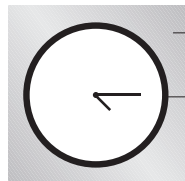

Clock Insert

Clock Bezel

Two Clock Options

1. 12-1/4" diameter radio controlled clock by Howard Miller* (#625-488)
2. 10-1/2" diameter standard battery opwered quartz clock by Howard Miller (#625-254)

* See www.apcosigns.com/myday.asp for important information, instructions and disclaimers regarding atomic clocks.

| Height | Width | Code |
|--------|-------|-----------------|
| 16" | 16" | MDCD1616 |
| 20" | 16" | MDCD2016 |

Finishes

Aluminum Clock Insert

- Natural Satin Anodized (standard)
- Painted
- Simulated Wood Vinyl

Clock Bezel

- Black

Hanger

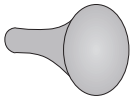

Finishes

Natural Satin Aluminum (standard)
 Painted Black Aluminum (optional)
Other finishes not recommended

Important

Standard locations for hangers:
 Single: Centered on 16" module
 Double: Centered (see cover photo).
 Otherwise, exact locations need to be specified by client.

Hanger holes are pre-drilled into bottom of frame/cabinet and hangers are attached by customer.

Code

MDHNGR

2" Shelf

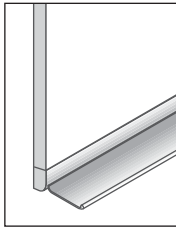

Finishes

Satin Aluminum
Other finishes not recommended

Ships unassembled. Attachment by customer with provided peel-and-stick adhesive.

Width

16"

20"

Code

MDSHLF16

MDSHLF20

Magazine Holder

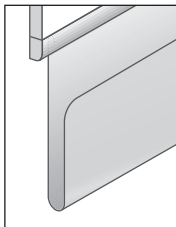

Finishes

Satin Aluminum
Other finishes not recommended

Ships unassembled. Attachment by customer with provided set screw.

Code

MDMHLDR

Notifier Clip

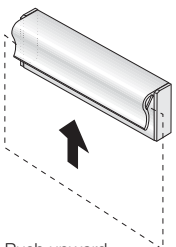

Push upward to grip paper.

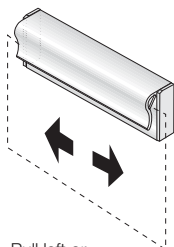

Pull left or right using both hands to release.

Finishes

Satin Aluminum (standard)
 Painted (optional)

Width

16"

20"

Code

MDSB30N16

MDSB30N20