

**The Original Modular
System and Winner of
the Design of the
Decade Award by the
Industrial Designers
Society of America**



Product Description

IM System®

The IM Sign Module is precision molded of an automotive grade, high-impact engineering plastic which is lightweight, durable and suitable for both interior and exterior use. The eight IM System colors are an integral* part of the molded material.

The standard graphic application is a photographic screenprinting technique whereby the image forms a chemical bond with the insert surface. A diverse range of optional graphic applications such as applied vinyl letters may also be used. The ClearLens Modules can be used with SignWord® laser printed paper inserts.

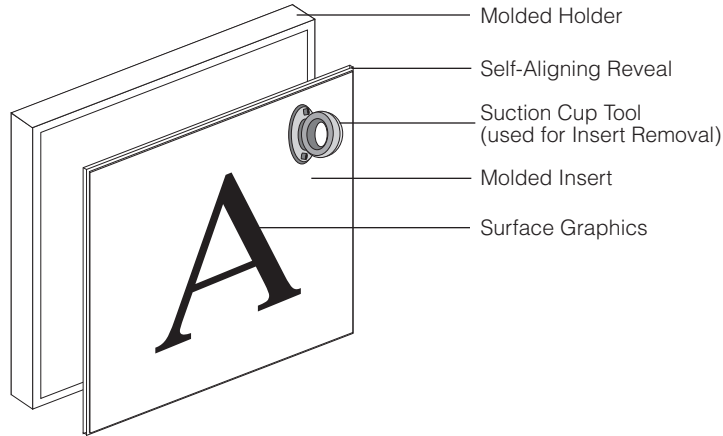

Holder & Insert Colors

Colors are integral* to the molded plastic.

Standard

- A02 Black
- A43 Putty
- A44 Architectural Brown
- A47 Light Grey
- A71 Harvard Green
- A72 Bone White
- A74 Indy Blue
- A78 Pearl Grey

Polyurethane Coated

- 44+ Standard
- Custom

*Subject to availability. Certain parts may be polyurethane coated to achieve specified color. Consult APCO for details.

Corner Shapes

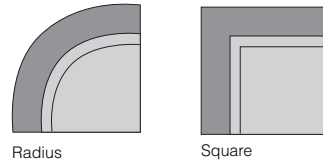

Edge Shapes

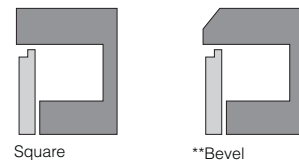

**Bevel Edge is only available for Square Corner Holders.

IM System with ADA Process 1

A photosensitive plastic is fused to a rigid plastic base, which is machined and finished to simulate the IM insert.

Images are photographically generated, allowing an unlimited choice of typestyles and layouts. The photoetched plastic is surface coated, providing a wide range of background and graphics color choices.

Specification Information

IM Inserts with ADA Feature are specified by adding the suffix "-A" to the insert product number.

Example: RI-88-A

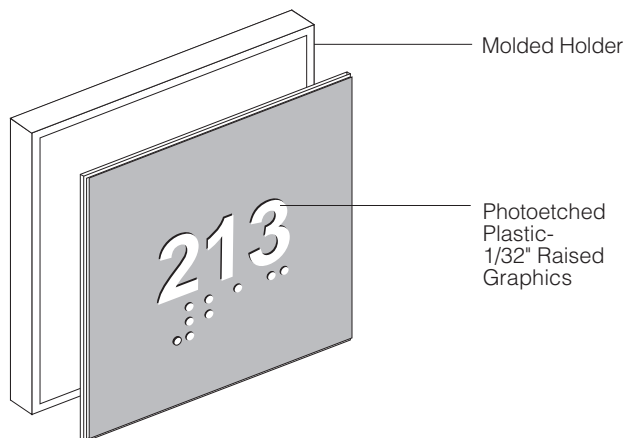

Dimensions & Weights

Dimensions are given in both inches and metric.

To convert from grams to ounces, divide by 28.35. To convert from ounces to grams, multiply by 28.35.

Wall & Panel Holders

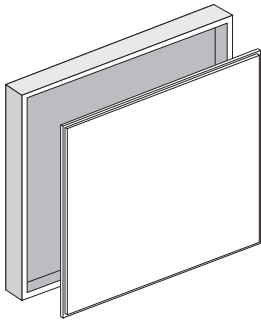

Prefix:

RH Radius Holder
SH Square Holder
BH Bevel Edge Holder*

*Bevel Edge is only available for Square Corner Holders.

Nominal Dimensions	Product Number			Weight
	Radius	Square	Bevel Edge	
1-1/2 x 8 38 x 203	RH-158	SH-158	BH-158	51g.
4 x 4 102 x 102	RH-44	SH-44	BH-44	52g.
4 x 8 102 x 203	RH-48	SH-48	BH-48	106g.
6 x 6 152 x 152	RH-66	SH-66	BH-66	111g.
6 x 12 152 x 305	RH-612	SH-612	BH-612	224g.
8 x 8 203 x 203	RH-88	SH-88	BH-88	213g.
12 x 12 305 x 305	RH-1212	SH-1212	BH-1212	441g.
16 x 16 406 x 406	RH-1616	SH-1616 **	BH-1616 **	664g.

** These holders are custom fabricated of aluminum using APCO's modular Sign Track system. Overall look and function are the same as other IM holders.

Desk Holders

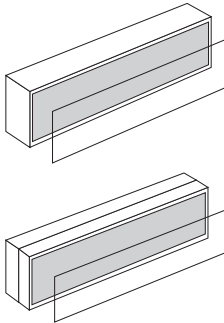

Nominal Dimensions	Product Number			Weight
	Radius	Square	Bevel Edge	
1-1/2 x 8 38 x 203 Single Sided	RD(S)	SD(S)	BD(S)	111g.
1-1/2 x 8 38 x 203 Double Sided	RD(D)	SD(D)	BD(D)	115g.

Attachment Methods

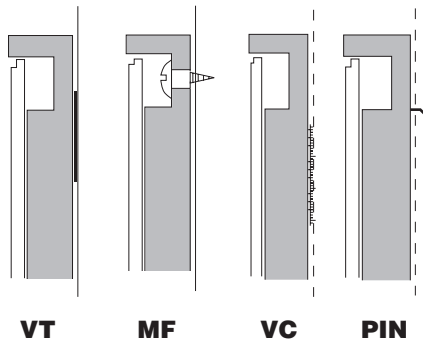

Vinyl Tape (VT) is used for any smooth non-porous surface. If the surface is uneven or textured, ask for silicone adhesive (VT/SAM) to supplement the vinyl tape.

Mechanical Fastening (MF) is to be used when more permanent attachment than vinyl tape is required.

Velcro (VC) can be used to attach signs to fabric-covered surfaces. Check fabric surfaces for compatibility.

PinLock™ (PIN) fasteners are used to attach Personnel Signs to fabric covered walls. They will not damage the fabric and do not penetrate the core material.

Compatible holder sizes: 1-1/2 x 8, 4 x 4, 6 x 6, and 4 x 8.

One-Piece Inserts

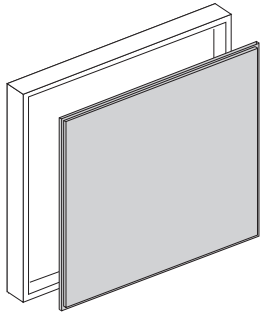

Prefix:
RI–Radius Insert
SI–Square Insert

Suffix:
-A–ADA Process 1

Nominal Dimensions*	Product Number Radius	Square	Weight
1-1/2 x 8 38 x 208	RI-158	SI-158	26g.
4 x 4 102 x 102	RI-44	SI-44	37g.
4 x 8 102 x 203	RI-48	SI-48	70g.
6 x 6 152 x 152	RI-66	SI-66	80g.
6 x 12 152 x 305	RI-612	SI-612	173g.
8 x 8 203 x 203	RI-88	SI-88	150g.
12 x 12 305 x 305	RI-1212	SI-1212	307g.
16 x 16 406 x 406	RI-1616	SI-1616	587g.

Split Inserts

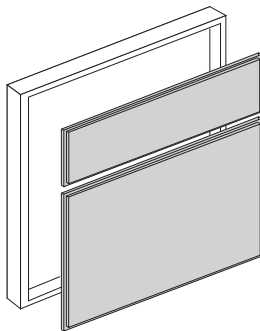







Prefix:
RI–Radius Insert
SI–Square Insert

Suffix:
T–Top Insert
B–Bottom Insert

L–Left Insert
R–Right Insert

-A–ADA Process 1

Split Inserts	Nominal Dimensions*	Product Number Radius	Square	Holder Size	Weight
	1-1/2 x 4 38 x 102	RI-154T	SI-154T	4 x 4	12g.
	2-1/2 x 4 64 x 102	RI-254B	SI-254B	4 x 4	21g.
	4 x 4 102 x 102	RI-44L	SI-44L	4 x 8	34g.
	4 x 4 102 x 102	RI-44R	SI-44R	4 x 8	34g.
	1-1/2 x 8 38 x 203	RI-158T	SI-158T	4 x 8	25g.
	2-1/2 x 8 64 x 203	RI-258B	SI-258B	4 x 8	45g.
	2 x 6 51 x 152	RI-26T	SI-26T	6 x 6	28g.
	4 x 6 102 x 152	RI-46B	SI-46B	6 x 6	54g.
	2 x 12 51 x 305	RI-212T	SI-212T	6 x 12	60g.
	4 x 12 51 x 305	RI-412B	SI-412B	6 x 12	110g.
	6 x 6 152 x 152	RI-66L	SI-66L	6 x 12	100g.
	6 x 6 152 x 152	RI-66R	SI-66R	6 x 12	100g.
	2 x 8 51 x 203	RI-28T	SI-28T	8 x 8	36g.
	6 x 8 152 x 203	RI-68B	SI-68B	8 x 8	109g.

*Nominal dimensions are for the insert plateau and do not include reveal dimensions.

Coupon Books for 1-1/2 x 8 Personnel Sign Inserts

For ease in reordering and to avoid future minimum billing requirements, prepaid coupon books are available for ordering replacement 1-1/2 x 8 Personnel Sign Inserts. Each book contains 10, 25 or 50 coupons for ordering replacement inserts. Shipping and handling are included.

Quantity of Strips	Product No. 1-1/2" x 8" NAME ONLY	Product No. 1-1/2" x 8" NAME & TITLE
10	C/1 Line-10	C/2 Line-10
25	C/1 Line-25	C/2 Line-25
50	C/1 Line-50	C/2 Line-50

Window Signs

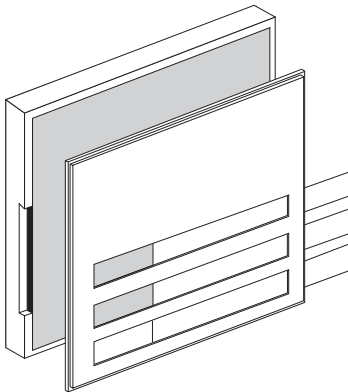

Window Sign Inserts

Window sign inserts are designed for situations where messages are subject to frequent changes. Slots milled into the sign accept message inserts which may be easily removed.

Message strips are described on page 4.5.31

Prefix:

RI—Radius Insert
SI—Square Insert

Suffix:

1—One Window
11—Two Windows
3—Three Windows
4—Four Windows
2—One Large (1-15/16") Window

Slotted Holders

This optional feature facilitates insertion and removal of message strips without removing sign insert from holder.









Prefix:

RH—Radius Holder
SH—Square Holder
BH—Bevel Edge Holder*

*Bevel Edge is only available for Square Corner Holders

Suffix:

2—Slot for One or Two Window Inserts
3—Slot for Three Window Inserts
4—Slot for Four Windows Inserts

Window Inserts	Nominal Dimensions*	Insert Product No. RI/SI	Weight	Slotted Holder No. RH/SH/BH	Weight
	6 x 6 152 x 152	RI-66-1 SI-66-1	70g.	RH-66-2 SH-66-2 BH-66-2	110g.
1 — One 15/16 x 6 Strip					
	6 x 6 152 x 152	RI-66-11 SI-66-11	63g.	RH-66-2 SH-66-2 BH-66-2	110g.
11 — Two 15/16 x 6 Strip					
	6 x 6 152 x 152	RI-66-3 SI-66-3	61g.	RH-66-3 SH-66-3 BH-66-3	104g.
3 — Three 15/16 x 6 Strip					
	6 x 6 152 x 152	RI-66-2 SI-66-2	57g.	RH-66-2 SH-66-2 BH-66-2	110g.
2 — One 1-15/16 x 6 Strip					
	8 x 8 203 x 203	RI-88-1 SI-88-1	154g.	RH-88-2 SH-88-2 BH-88-2	210g.
1 — One 15/16 x 8 Strip					
	8 x 8 203 x 203	RI-88-11 SI-88-11	145.5g.	RH-88-2 SH-88-2 BH-88-2	210g.
11 — Two 15/16 x 8 Strip					
	8 x 8 203 x 203	RI-88-4 SI-88-4	125.5g.	RH-88-4 SH-88-4 BH-88-4	202g.
4 — Four 15/16 x 8 Strip					
	8 x 8 203 x 203	RI-88-2 SI-88-2	145g.	RH-88-2 SH-88-2 BH-88-2	210g.
2 — One 1-15/16 x 8 Strip					

*Nominal dimensions are for the insert plateau and do not include reveal dimensions.

4.5.105

10/04

Custom Window Sign Message Strips

Custom Message Strips – Thin plastic strips are available in four sizes in five painted colors: A1, A2, A43, A44, A47. These message strips are surface printed. The background color is applied to the backside.



Blank Message Strips – Thin plastic strips are available in four sizes in five painted colors: A1, A2, A43, A44, A47.

User-lettering Message Strips – Using SignWord, create message strips in-house. See Section 4.8.

Product Number	Strip Size
MS/V16	15/16" x 6"
MS/V18	15/16" x 8"
MS/V26	1-15/16" x 6"
MS/V28	1-15/16" x 8"

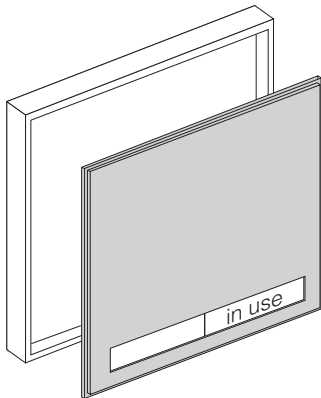
Changeable Sliding Sign Inserts



CSS Inserts	Nominal Dimensions*	Product Number	Weight
	6 x 6 152 x 152	RI-66CSS SI-66CSS	100g.
	8 x 8 203 x 203	RI-88CSS SI-88CSS	115.5g.

*Nominal dimensions are for the insert plateau and do not include reveal dimensions.

Prefix:

RI–Radius Insert

SI–Square Insert

Suffix:

CSS–Changeable Sliding Sign

SnapLock ClearLens Inserts

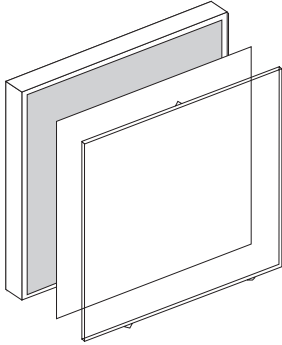

A clear, non-glare SnapLock insert protects laser printed paper inserts.

Painting of holders to be used with SnapLock inserts is not recommended.

Nominal Dimensions*	Product Number		Weight
	Radius	Square	
1-1/2 x 8 38 x 203	RI/SL-158	SI/SL-158	29g.
4 x 4 102 x 102	RI/SL-44	SI/SL-44	36g.
4 x 8 102 x 203	RI/SL-48	SI/SL-48	73g.
6 x 6 152 x 152	RI/SL-66	SI/SL-66	84g.
6 x 12 152 x 305	RI/SL-612	SI/SL-612	204g.
8 x 8 203 x 203	RI/SL-88	SI/SL-88	156g.
12 x 12 305 x 305	RI/SL-1212	SI/SL-1212	376g.

*Nominal dimensions are for the insert plateau and do not include reveal dimensions.

ADA ClearLens Inserts

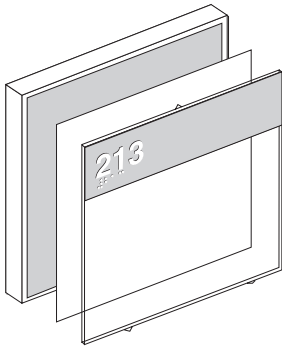

Standard Sizes

2" x 4"
2" x 6"
2" x 8"

For ADA compliance, thin bands of photosensitive plastic may be applied to any portion of the ClearLens.

SignWord/User Lettering Accessories

Paper Insert Packages

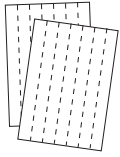

Standard Paper Insert Colors

A43 Putty / A94 Sand (on reverse)
A47 Light Grey
A72 Bone White / A00 White (on reverse)
A78 Pearl Grey

Product Code	For	Yield per Package
SWS158 (Square)	1-1/2" x 8" Holder	200
SWR158 (Radius)		
SWS44 (Square)	4" x 4" Holder	100
SWR44 (Radius)		
SWS48 (Square)	4" x 8" Holder	50
SWR48 (Radius)		
SWS66 (Square)	6" x 6" Holder	50
SWR66 (Radius)		
SWS88 (Square)	8" x 8" Holder	50
SWR88 (Radius)		
SWS612 (Square)	6" x 12" Holder	50
SWR612 (Radius)		
SWMS16	1" x 6" Message Window	900
SWMS18	1" x 8" Message Window	550



User Lettering Solution!

SWPRO

SignWord® Pro Software
Download for FREE at apcosigns.com!

Minimum System Requirements

PC running Windows® 3.x/95/98/NT
16 MB RAM
5 MB free disk space
Laser or Inkjet printer

3 Easy Steps

1 Create

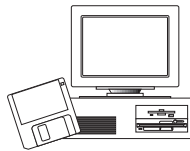

With SignWord Pro Software, enter your message and symbols using preestablished formats or your own custom layouts.

2 Print

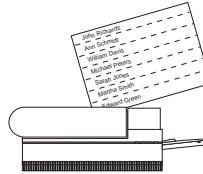

Print the image on a special paper that is perforated and colored to match the sign holder.

3 Insert

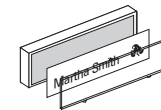

Punch out the sign insert and place it in the Insert Slot or Clear Band and PRESTO - in less than 60 seconds a complete sign!

APCO Imprinted and/or Blank Individual Paper Inserts

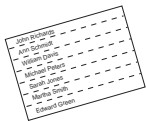



Black laser printed copy/graphics standard.
Color laser printed graphics optional. Consult factory.

Standard Paper Insert Colors

A43 Putty / A94 Sand (on reverse)
A47 Light Grey
A72 Bone White / A00 White (on reverse)
A78 Pearl Grey

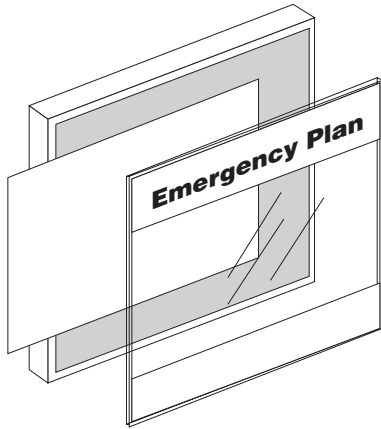
Product Code	For
SWS158-1 (Square)	1-1/2" x 8" Holder
SWR158-1 (Radius)	
SWS44-1 (Square)	4" x 4" Holder
SWR44-1 (Radius)	
SWS48-1 (Square)	4" x 8" Holder
SWR48-1 (Radius)	
SWS66-1 (Square)	6" x 6" Holder
SWR66-1 (Radius)	
SWS88-1 (Square)	8" x 8" Holder
SWR88-1 (Radius)	
SWS612-1 (Square)	6" x 12" Holder
SWR612-1 (Radius)	

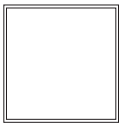

Holders	Nominal Dimensions	Product No. RH/SH/BH	Weight
	12 x 12 305 x 305	RH-1212 SH-1212 BH-1212	441g.
Insert	Nominal Dimensions	Product No. RI/SH/BI	Weight
	12 x 12 305 x 305	RI-1212EP SI-1212EP	200g.

The 12" x 12" window insert accepts 8-1/2" x 12" photocopied or printed paper maps. The window insert is retained with PresLock fasteners.

Standard Header copy reads:
"Emergency Plan"

Typestyle and size:
1" Helvetica Medium, INC.

Prefix:
RH–Radius Holder
SH–Square Holder
BH–Bevel Edge Holder*

*Bevel Edge is only available for Square Corner Holders.

Prefix:
RI–Radius Insert
SI–Square Insert

Suffix:
EP–Emergency Plan

Floorplan Paper

Packages of (50) sheets of 8-1/2" x 12" paper are available for use in most photocopiers to reproduce floorplans. These sheets are available in the following colors, with one color per package.

Standard Paper Insert Colors

A43 Putty / A94 Sand (on reverse)
A47 Light Grey
A72 Bone White / A00 White (on reverse)
A78 Pearl Grey

FE/43-94 A43 Putty / A94 Sand (on reverse)	8-1/2" x 12" 216 x 305	50
FE/47 A47 Light Grey	8-1/2" x 12" 216 x 305	50
FE/72-00 A72 Bone White / A00 White (on reverse)	8-1/2" x 12" 216 x 305	50
FE/78 A78 Pearl Grey	8-1/2" x 12" 216 x 305	50

Ceiling Mounting Fixtures

Ceiling Fixtures

Option 1 – Ceiling Mount (CM)

For Sheet Rock or Other Smooth Surfaces

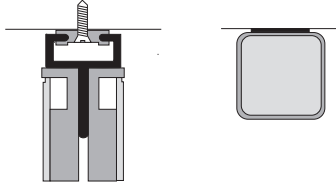

The Ceiling Mount (CM) fixture, slides over an aluminum track which attaches to the mounting surface with concealed screws (not included). The plastic fixture slides over the aluminum track and matching end caps close ends. Both the fixture and end caps are available in all eight IM System colors, or may be custom painted.

Product Number	For Sign Modules (HxW)
CM	4" x 4"
	4" x 8"
	6" x 6"
	6" x 12"
	8" x 8"
	12" x 12"
	16" x 16"
	Director Modules*

NOTE: A ceiling mounted Director requires 2 Header Inserts, 2 Base Inserts, 2 Header Holders and 2 Base Holders. Sometimes center inserts and holders may also be included.

Option 2 – Ceiling Mount Clip (CMC)

For Standard Suspended Ceiling Grid Tee Flange (15"/16")

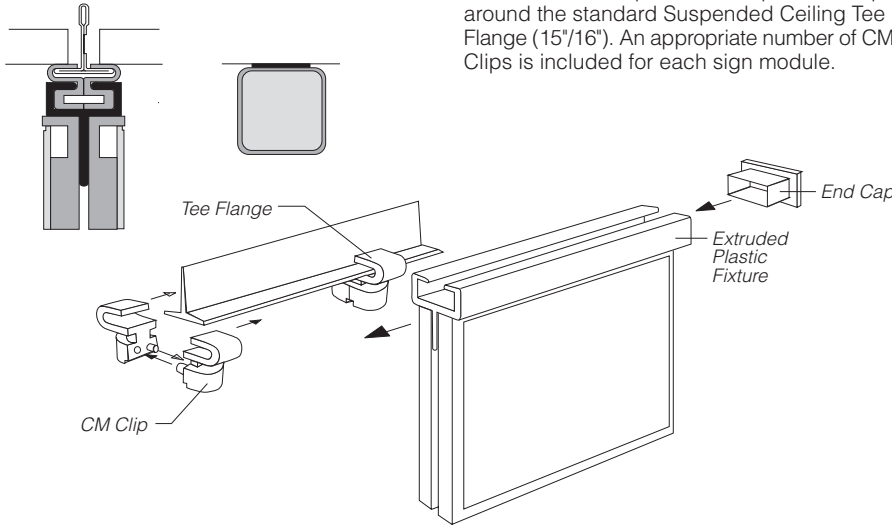

The Ceiling Mount Clip (CMC) fixture incorporates the same extruded plastic fixture as the CM fixture (Option 1) but the fixture slides over a clear plastic CM Clip which snaps around the standard Suspended Ceiling Tee Flange (15"/16"). An appropriate number of CM Clips is included for each sign module.

Product Number	For Sign Modules (HxW)
CMC	4" x 4"
	4" x 8"
	6" x 6"
	6" x 12"
	8" x 8"
	12" x 12"
	16" x 16"
	Director Modules*

Additional CM Clips

To order additional Ceiling Mount Clips, specify quantity and product number – **CMClip**

Option 3 – Ceiling Mount Extenders (CME)

For Standard Suspended Ceiling

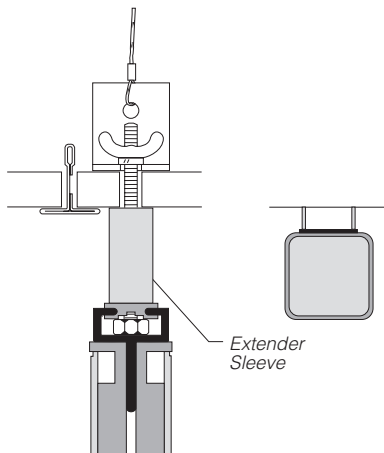

The Ceiling Mount Extenders (CME) allows the sign module to extend below ceiling level. When higher ceilings require extensions, the extenders may be specified in the lengths shown or custom sizes (consult factory). The sleeves may be painted to match the sign holder, or select from APCO Color System.

Product Number	Extender Length
CME-6	6"
CME-12	12"
CME-18	18"
CME-24	24"

Projecting Wall Mount Fixture

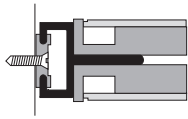

The Projecting Wall Mount (PWM) fixture features an aluminum track which attaches to the mounting surface with concealed screws (not included). The plastic fixture then slides over the aluminum track and matching end caps close the ends. Both the fixture and end caps are available in all eight IM System colors, or may be custom painted.

Product Number	For Sign Modules (HxW)
PWM	4" x 4"
(Screws Not Included)	8" x 4"
	6" x 6"
	12" x 6"
	8" x 8"
	12" x 12"
	16" x 16"

NOTE: For Projecting Wall Mount Signs, be sure to specify which side the fixture is to be placed (on the left or right) unless copy is exactly the same on both sides.

Fixed Dimension Panel Clip/ Fabricated

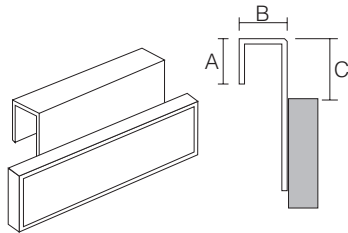

Panel Clips (PC) are available for 1-1/2" x 8" Holders. Shipped unattached, application is accomplished with vinyl tape which is pre-mounted on clips.

Panel Clips are fabricated from 1/8" clear acrylic.

Consult factory for Panel Clips in larger sizes.

Product Number	Dimensions
PC	Specify A, B & C dimensions as required.

Adjustable Panel Clip/Extruded

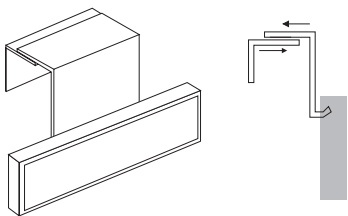

Adjustable Panel Clip/Extruded (PC/E) accommodates 1-1/8" to 2-3/16" panel thickness. Panel Clip/Extruded are available for most IM Holders. They are shipped unattached.

Product Number	For Holder Sizes
PC/E-3	4 x 4
PC/E-4	1-1/2 x 8, 6 x 6, 4 x 8, 8 x 8, 6 x 12, 12 x 12